

# Standard 30 MF

Maintenance-free Gyro Compass and Attitude Reference System

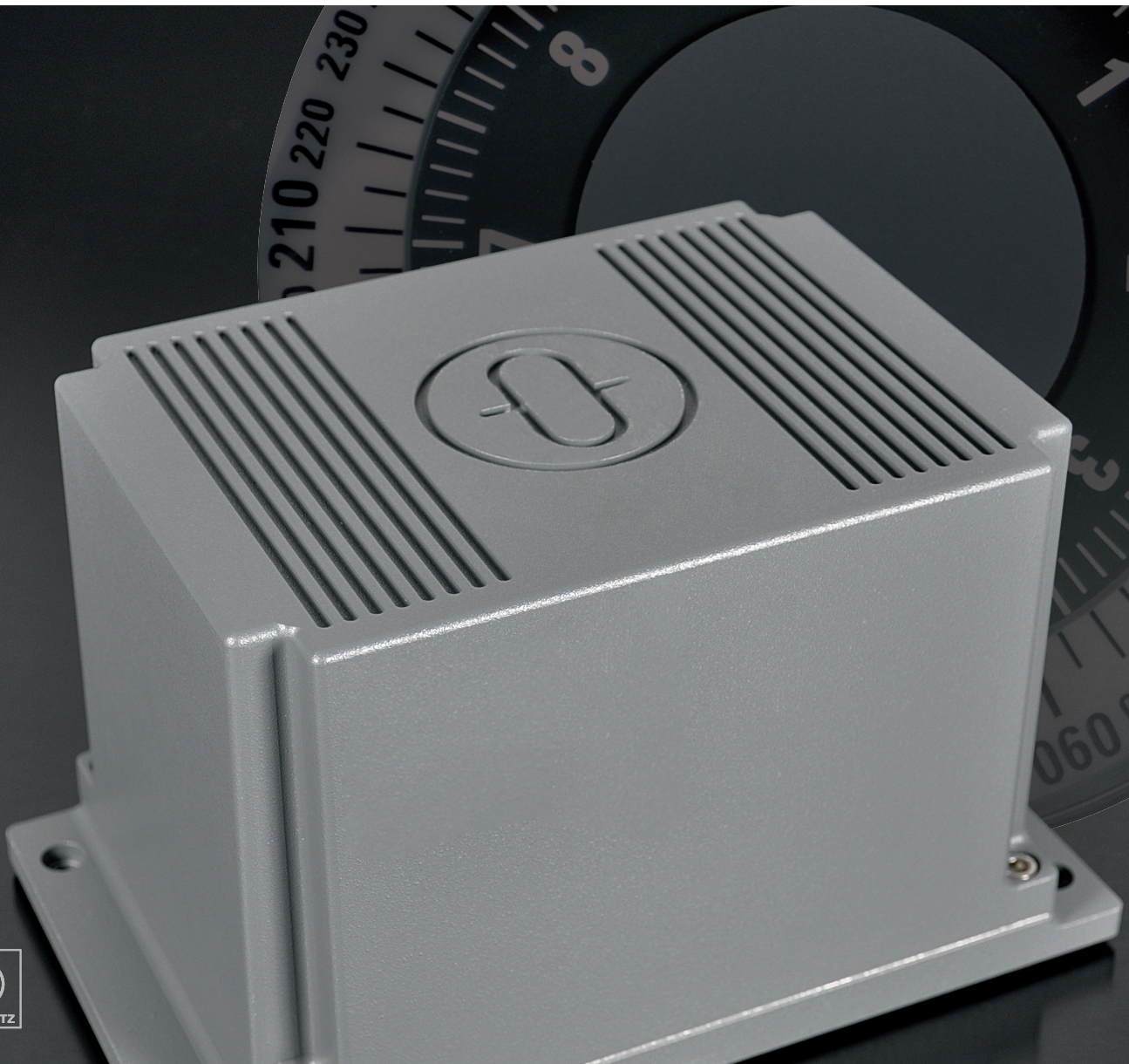

# Standard 30 MF Maintenance-free gyro compass

Standard 30 MF is the second generation of maintenance free gyro compasses from Raytheon Anschutz based on Hemispherical Resonator Gyro (HRG) technology. This sensor technology has been used in Horizon MF – the predecessor of Standard 30 MF – and has proven its reliability and accuracy.

The new Standard 30 MF is even smaller than its predecessor and features an optimized integration into a Raytheon Anschutz heading management system.

Developed with a strong focus on robustness, Standard 30 MF settles even at rough sea states and provides heading output even if speed and latitude input fails – a significant advantage over other compass systems.

## UNSURPASSED LIFETIME PERFORMANCE

Standard 30 MF uses Hemispherical Resonator Gyros (HRGs) as angular rate sensors. HRGs are vibrating resonator gyros consisting of only a few elementary pieces, assembled in a miniature hemisphere decoupled from the outside equipment: A single resonator and electronics for resonator control and vibration sensing. The simple design was engineered to make the gyro extremely reliable with no wear and tear and no need for maintenance.

The mean time between failure (MTBF) value of the HRG technology is more than 100,000 hours (which is multiple times higher than the MTBF values of fiber optical or ring laser gyros) bringing forth an outstanding long-term stability and lifetime.



Learn more about the new HRG technology:

[www.raytheon-anschutz.com/std30mf](http://www.raytheon-anschutz.com/std30mf)

Standard 30 MF offers an additional benefit for vessels with DP systems. Some classification societies permit replacing a motion reference unit (MRU) with the roll and pitch output from the Standard 30 MF. This reduces investment costs and also maintenance costs as no periodic drift calibration is required.



## BENEFITS AT A GLANCE

- High accuracy of 0.25 degrees, ultra-robust design
- High cost-effectiveness over lifetime thanks to maintenance-free technology
- Superior and durable HRG technology (MTBF >100,000 h)
- Significant better longterm stability than a FOG, no drift
- Heading sensor and MRU in one (roll and pitch output), thus reduction in investment and maintenance cost
- Settling time of only one hour, settles at rough sea states
- Heading monitor and selector with automatic switch-over (configurable)
- Automatic speed / latitude error correction
- Individual speed error correction
- Independent transmitting magnetic compass (TMC) path
- Ethernet interfaces for data communication with integrated navigation systems or central alert management displays
- Perfect for newbuild and retrofit projects or as an extension of Standard 22 gyro compass systems
- IMO approved for standard and high-speed crafts and as rate-of turn indicator



## MODULAR SYSTEM ARCHITECTURE

A modular product range enables different system configurations – from a single compass up to a multi compass system consisting of magnetic compass, Standard 22, Standard 30 MF and redundancy in distribution. A wide range of accessories (including self-aligning repeaters, and converters for retrofits) is available.

The integration into the heading management system is realized through redundant CAN interfaces. The CAN bus reduces the wiring effort between the components to a minimum, over a distance of up to 400 meters with real-time communication.

### Standard 30 MF standalone

The stand-alone system comes with 4 serial output interfaces and an analog +/-10V interface for rate-of-turn. Therefore, the Standard 30 MF can also be used as a rate-of-turn indicator (required for vessels above 50.000 GT). Speed and latitude are taken in as serial data. Automatic speed / latitude error correction are standard features. In addition, the Ethernet interfaces can be used for data communication, e.g. with an integrated navigation system.

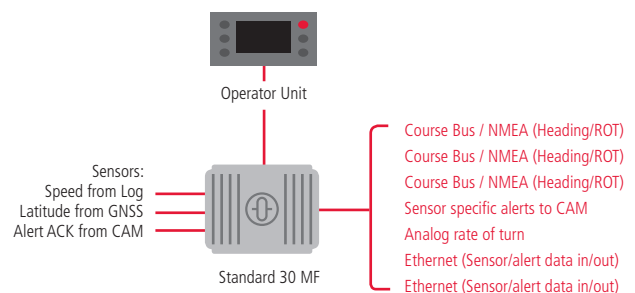

### Standard 30 MF heading management system

The heading management system allows to connect up to 3 gyro compasses and integrates a magnetic compass or GNSS compass. 12 serial outputs are available in addition to the outputs of the Standard 30 MF for the connection of heading receivers, such as for repeaters, autopilots, radars amongst others. Sensor selection is done with the operator unit. The monitoring threshold for a heading difference between different compasses can be defined by the user and is continuously monitored.

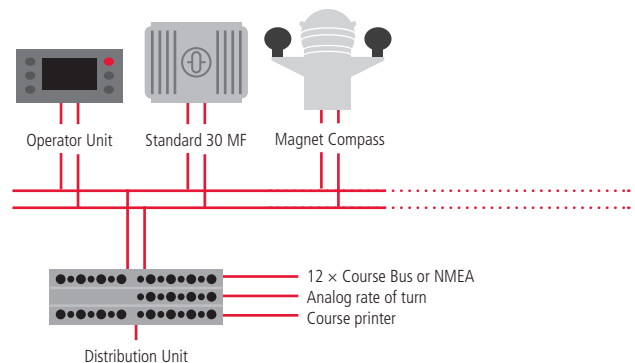

### Standard 30 MF heading management system with redundancy in distribution

This system provides a redundancy of the distribution system – in addition to the redundancy of compasses, so no single failure causes a loss of heading information to the connected heading receivers. This system (with two gyros) is compliant to the demanding class notations DNVGL NAUT-OSV/OC/AW, LR IBS and ABS NIBS.

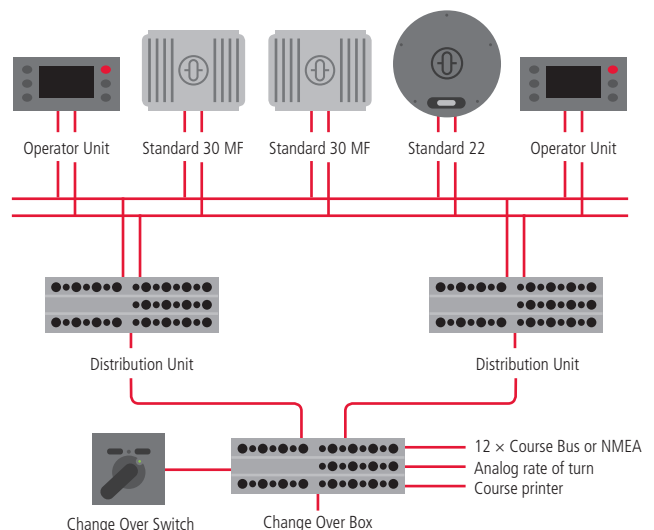

## TECHNICAL DATA

### Accuracy

- Heading 0.25° secLat RMS
- Roll & pitch 0.2° RMS
- Rate of turn 0.5°/min plus 5% of the indicated rate of turn
- secLat.=1/cosLatitude

### Supply voltage & power consumption

- 24 V DC (10 – 36 V DC)
- 24 W

### General data

Permissible ambient temperature

- Operation -20° C to +60° C
- Storage -30° C to +70° C
- Settling time 1h
- Permissible roll and pitch angle for full accuracy ±60°

### Data interfaces

Standard 30 MF

- 3x RS422 serial inputs
- 4x RS422 serial outputs (NMEA or Anschütz Course Bus)
- Analog +/- 10 V output for rate-of-turn
- 2x Ethernet
- 2x CAN bus

Distribution unit

- 2x RS422 serial inputs (for speed and latitude)
- 2x RS422 serial inputs (for other heading sensors, option)
- 12x RS422 serial outputs (NMEA or Anschütz Course Bus)

### Alerts

- System failure with potential-free relay contact
- ALR/ACK NMEA alert communication via RS422 interfaces (acc. to IEC 61162–1)
- INS alert communication via Ethernet (acc. to IEC 61924–2)

### In accordance with

- IMO A.424(XI), A694(17), A.821(19)
- IEC 60945, ISO 8728, ISO 16328, ISO 20672, IEC 61162

### Weight

- Standard 30 MF: 3,3 kg (without cables)

### Type of enclosure acc. to IEC/EN 60529

- Gyro compass IP 44
- Operator unit IP 23/IP 56 front sided
- Distribution unit IP 22

### Standard 30 MF

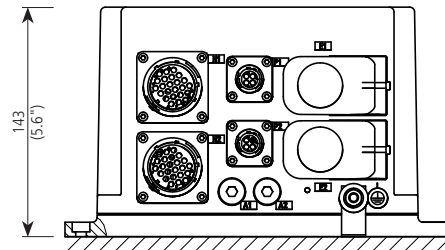
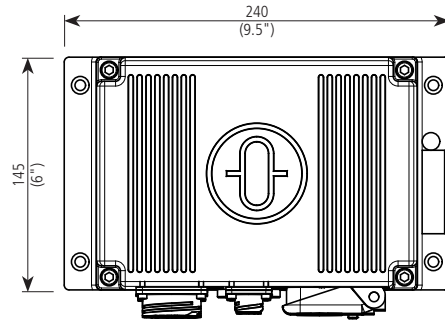

### Operator Unit

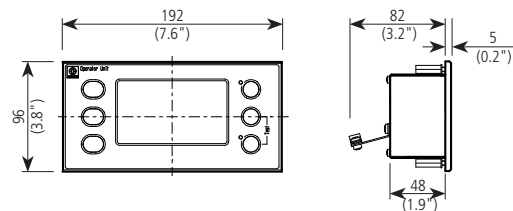

### Distribution Unit (option)

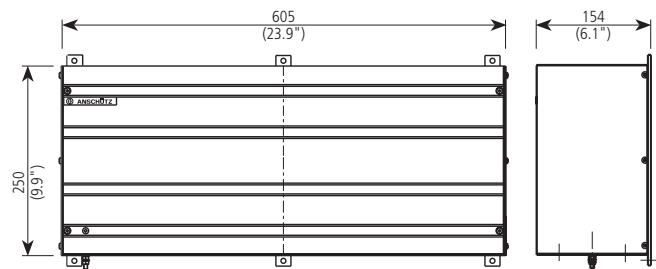

Subject to change due to technical developments without notice.  
 \* If not otherwise stated, all trademarks including Anschütz and  are registered by Raytheon Anschütz GmbH

All rights reserved · Printed in Germany  
 L&S 1019

**Raytheon Anschütz GmbH**  
 Headquarters  
 D-24100 Kiel, Germany  
 Tel +49(0)431-3019-0  
 Fax +49(0)431-3019-291  
 www.raytheon-anschuetz.com